



**Alltest Instruments, Inc.**

500 Central Ave.  
Farmingdale, NJ 07727

P: (732) 919-3339  
F: (732) 919-3332

**alltest.net**  
sales@alltest.net

## **The test & measurement equipment you need at the price you want.**

Alltest carries the world's largest selection of used/refurbished benchtop test & measurement equipment at 50% the price of new.

Our equipment is guaranteed working, warrantied, and available with certified calibration from our in-house staff of technicians and engineers.

- **10+ full time technicians with over 150 years of specialization**
- **90 day warranty & 5 day right of return on all equipment**
- **1-3 year warranties for new and premium-refurbished equipment**
- **Every unit tested to OEM specifications**
- **Satisfaction guaranteed**

You have plans, we will help you achieve them.  
*Any project. Any budget.*

### **Get a quote today!**

Call (732) 919-3339 or email sales@alltest.net.

**FLUKE®**

# **68x Series**

Enterprise LANMeter®

## Getting Started

PN 1546949  
January 2000

© 2000 Fluke Corporation. All rights reserved. Printed in USA  
All product names are trademarks of their respective companies.

## LIMITED WARRANTY AND LIMITATION OF LIABILITY

Each Fluke product is warranted to be free from defects in material and workmanship under normal use and service. The warranty period is one year and begins on the date of shipment. Parts, product repairs, and services are warranted for 90 days. This warranty extends only to the original buyer or end-user customer of a Fluke authorized reseller, and does not apply to fuses, disposable batteries, or to any product which, in Fluke's opinion, has been misused, altered, neglected, contaminated, or damaged by accident or abnormal conditions of operation or handling. Fluke warrants that software will operate substantially in accordance with its functional specifications for 90 days and that it has been properly recorded on non-defective media. Fluke does not warrant that software will be error free or operate without interruption.

Fluke authorized resellers shall extend this warranty on new and unused products to end-user customers only but have no authority to extend a greater or different warranty on behalf of Fluke. Warranty support is available only if product is purchased through a Fluke authorized sales outlet or Buyer has paid the applicable international price. Fluke reserves the right to invoice Buyer for importation costs of repair/replacement parts when product purchased in one country is submitted for repair in another country.

Fluke's warranty obligation is limited, at Fluke's option, to refund of the purchase price, free of charge repair, or replacement of a defective product which is returned to a Fluke authorized service center within the warranty period.

To obtain warranty service, contact your nearest Fluke authorized service center to obtain return authorization information, then send the product to that service center, with a description of the difficulty, postage and insurance prepaid (FOB Destination). Fluke assumes no risk for damage in transit. Following warranty repair, the product will be returned to Buyer, transportation prepaid (FOB Destination). If Fluke determines that failure was caused by neglect, misuse, contamination, alteration, accident, or abnormal condition of operation or handling, including overvoltage failures caused by use outside the product's specified rating, or normal wear and tear of mechanical components, Fluke will provide an estimate of repair costs and obtain authorization before commencing the work. Following repair, the product will be returned to the Buyer transportation prepaid and the Buyer will be billed for the repair and return transportation charges (FOB Shipping Point).

THIS WARRANTY IS BUYER'S SOLE AND EXCLUSIVE REMEDY AND IS IN LIEU OF ALL OTHER WARRANTIES, EXPRESS OR IMPLIED, INCLUDING BUT NOT LIMITED TO ANY IMPLIED WARRANTY OF MERCHANTABILITY OR FITNESS FOR A PARTICULAR PURPOSE. FLUKE SHALL NOT BE LIABLE FOR ANY SPECIAL, INDIRECT, INCIDENTAL, OR CONSEQUENTIAL DAMAGES OR LOSSES, INCLUDING LOSS OF DATA, ARISING FROM ANY CAUSE OR THEORY.

Since some countries or states do not allow limitation of the term of an implied warranty, or exclusion or limitation of incidental or consequential damages, the limitations and exclusions of this warranty may not apply to every buyer. If any provision of this Warranty is held invalid or unenforceable by a court or other decision-maker of competent jurisdiction, such holding will not affect the validity or enforceability of any other provision.

Fluke Corporation  
P.O. Box 9090  
Everett, WA 98206-9090  
U.S.A.

Fluke Europe B.V.  
P.O. Box 1186  
5602 BD Eindhoven  
The Netherlands

# Table of Contents

Title	Page
Introduction .....	1
Fluke 68x Series Instruments.....	1
Options .....	2
Functions .....	3
Equipment Supplied .....	4
Interface Mode Icons.....	4
Setting Up Your Instrument .....	4
Connecting the AC Adapter.....	5
Changing the Network Interface.....	6
User Interface .....	6
LCD Display.....	8
Keyboard .....	10
LED Indicators .....	21
Setup/Utils.....	26
Network Configuration.....	28
Ethernet .....	28
Station List .....	30
Manage Options .....	30
File Manager.....	30
Terminal Emulator.....	31
System Information .....	31
Update Software .....	31
Time and Date .....	31
Display Configuration .....	32
Self-Test .....	33
Self Test.....	33
Keyboard Test .....	33
Serial Test.....	34
100 MHz Cable Remote Test.....	34
Attaching Cables .....	34
TO MAU, TO HUB, or BNC Connection .....	36
TO NIC Connection.....	39
Expert-T Autotest Connection.....	40
Running a Test.....	41
Auto Test .....	42
Overview of Tests.....	43
Index.....	51



## List of Tables

Table	Title	Page
1.	LANMeter Instrument Network Configuration .....	2
2.	Valid Serial #s for Upgraded 67x Series.....	2
3.	Arrow Key Functions.....	17
4.	Battery Charger Status LED .....	26
5.	Cable and Media Information and Problems .....	43
6.	Ethernet NIC and Hub Problems .....	43
7.	Ethernet Performance Information .....	44
8.	Ethernet and Token Ring Network Information .....	44
9.	Token Ring Network Information .....	45
10.	Token Ring NIC and MAU Problems .....	46
11.	Novell NetWare Network Information .....	47
12.	TCP/IP Configuration and Performance.....	48
13.	Banyan VINES Client/Server Connectivity.....	49
14.	NetBIOS Configuration and Performance .....	49
15.	Utilities.....	50



## List of Figures

Figure	Title	Page
1.	Network and AC Adapter Connectors (686/685 Shown)	5
2.	LANMeter Instrument User Interface (Fluke 686 Shown)	7
3.	LCD Display Areas.....	8
4.	Keyboard and LEDs (686/685 Shown).....	10
5.	Ethernet Softkey Tree (Version 9.50).....	12
6.	Token Ring Softkey Tree (Version 9.50).....	13
7.	Ethernet Top-Level Softkeys (Version 9.50).....	14
8.	Token Ring Top-Level Softkeys (Version 9.50).....	14
9.	Alphanumeric Keys.....	20
10.	Network and AC Adapter Connectors (686/685 Shown)	24
11.	Network and AC Adapter Connectors (683/682 Shown)	25
12.	Network and AC Adapter Connectors (680 Shown) .....	25
13.	Setup/Utils Softkeys (Version 9.50).....	27
14.	Configuration Pop-up Menu.....	27
15.	User Interface (Fluke 686 shown).....	35
16.	TO HUB/MAU Connection Using RJ-45 Connector .....	36
17.	BNC Connection.....	37
18.	TO NIC Connection.....	39
19.	Expert-T Autotest Connections.....	40



# **68x Series Enterprise LANMeter**

## ***Introduction***

This manual helps you become familiar with and quickly begin using your 68x Series LANMeter instrument. Basic information is provided that will allow you to set up your instrument, configure and operate it. Detailed information about specific features is provided in the *Enterprise LANMeter 68x Series Users Manual* (P/N 1546951). The *Users Manual* is contained on the CD that came with your instrument. Adobe Acrobat Reader is required to view the *Users Manual* and is included on the CD or can be downloaded from [www.adobe.com](http://www.adobe.com).

## ***Fluke 68x Series Instruments***

The Fluke Enterprise LANMeter (68x Series) instruments are versatile battery-operated handheld instruments used to isolate many problems that can occur on your Ethernet and Token Ring networks. The Fluke Enterprise LANMeter series consists of the Fluke 686, Fluke 685, Fluke 683, Fluke 682, and Fluke 680 LANMeter instruments.

## 68x Series

### Getting Started

---

**Table 1. LANMeter Instrument Network Configuration**

<b>Model #</b>	<b>10 Mbps Ethernet</b>	<b>100 Mbps Ethernet</b>	<b>4 Mbps Token Ring</b>	<b>16 Mbps Token Ring</b>
680			X	X
682	X			
683	X	X		
685	X		X	X
686	X	X	X	X

The majority of this manual describes operations common to the Fluke 686, 685, 683, 682, and 680. Any differences between the LANMeter instruments are pointed out as appropriate.

## Options

The 100 MHz Cable Test option (also called 100 MHz Remote) gives you additional cable test capabilities. The 100 MHz Remote is compatible with all Fluke 68x Series instruments except some Fluke 67x Series instruments upgraded to 68x Series. Your 67x instrument is compatible with the 100 MHz Remote if its serial number is as described in Table 2 or if your instrument displays **100 MHz Cable Test Compatible** in the power-on screen or in the top-level softkey screen. The 100 MHz Cable Test option is covered in the *Users Manual*, “Testing Cables and Connectors.”

**Table 2. Valid Serial #s for Upgraded 67x Series**

<b>Model #</b>	<b>Valid Serial #s for Upgraded 67x Series 100 MHz Remote Compatibility</b>
670	> 6311801
672	> 6296601
675	> 6281701

The SwitchWizard option enhances Segment Discovery and adds the SwitchWizard MultiPort Statistics test. SwitchWizard gives you the ability to discover and diagnose problems on the other side of Ethernet, Token Ring, and

FDDI switches. SwitchWizard is compatible with all Fluke 68x Series instruments with software version 7.0 or greater, and is covered in the *Users Manual*, “SwitchWizard Option.”

The WideAreaWizard option enhances the Internet Toolkit’s Interface Table by adding reporting and some configuration capabilities for discovered WAN interfaces. WideAreaWizard gives you the ability to discover and diagnose problems on Frame Relay, ISDN, and T1/E1 interfaces on routers, switches, and bridges. WideAreaWizard also allows you to display and configure virtual circuit information for appropriate technologies. WideAreaWizard is compatible with all Fluke 68x Series instruments with software version 8.0 or greater, and is covered in the *Users Manual*, “WideAreaWizard Option.”

The WebRemote Control option adds the ability to control your LANMeter instrument remotely using a web browser. It is also required to use the Network Inspector LANMeter Edition reporting and monitoring package (see [www.fluke.com/nettools](http://www.fluke.com/nettools) for more information on Network Inspector). WebRemote Control is compatible with all Fluke 68x Series instruments with software version 9.0 or greater, and is covered in the *Users Manual*, “Web Agent / WebRemote Control.”

The Terminal Emulator option adds a command line interface that allows you to inspect or change the configuration of a network device by utilizing your LANMeter instrument’s serial port connection. Terminal Emulator is included whenever you purchase the SwitchWizard or WideAreaWizard options. Terminal Emulator operation is covered in the *Users Manual*, “Terminal Emulator.”

## **Functions**

This manual generally refers to features common to all the Fluke 68x Series LANMeter instruments as the “Enterprise LANMeter” or as the “LANMeter instrument.” The individual Fluke 68x Series model number is used when features are specific to an individual model of the Enterprise LANMeter.

Use the LANMeter instrument to perform the following functions on your network:

- Diagnose problems with network cabling
- Test key network components
- Monitor important attributes of the network environment

## 68x Series

### Getting Started

---

Refer to the *Users Manual* for specific information on using your LANMeter instrument.

## Equipment Supplied

The following equipment is supplied with the LANMeter instrument:

- Combination Wire Map and Cable Identifier #0 Remote Adapter
- Instrument Case
- Getting Started Manual
- Users Manual (on CD)
- AC Adapter/Battery Charger
- 3 ½-inch Utility Diskette

## Interface Mode Icons

 This icon is used in this manual to signify that the text that follows refers to the Ethernet interface only. The Fluke 683 and 682 have the Ethernet interface only and the Fluke 686 and 685 can be switched between the Ethernet and Token Ring interfaces.

 This icon is used in this manual to signify that the text that follows refers to the Token Ring interface only. The Fluke 680 has the Token Ring interface only and the Fluke 686 and 685 can be switched between the Ethernet and Token Ring interfaces.

## Setting Up Your Instrument

The following sections describe the initial setup and use of your instrument.

- Connecting the AC Adapter
- Changing the Network Interface
- User Interface
- Setup/Utils
- Attaching Cables
- Running a Test

## **Connecting the AC Adapter**

Connect the AC Adapter to the AC Adapter connector as shown in Figure 1. The AC Adapter power cord must be connected to a power receptacle with Earth Ground. Turn the power switch located on top of the instrument to **ON**. You can now use your instrument while the battery is charging.

**Before using the instrument without the AC Adapter, charge the battery for about 3 hours.**

Charge the battery or use the AC Adapter when the instrument displays a low battery indicator on the status line just above the softkey labels. You can use a fully charged battery for about 3 hours.

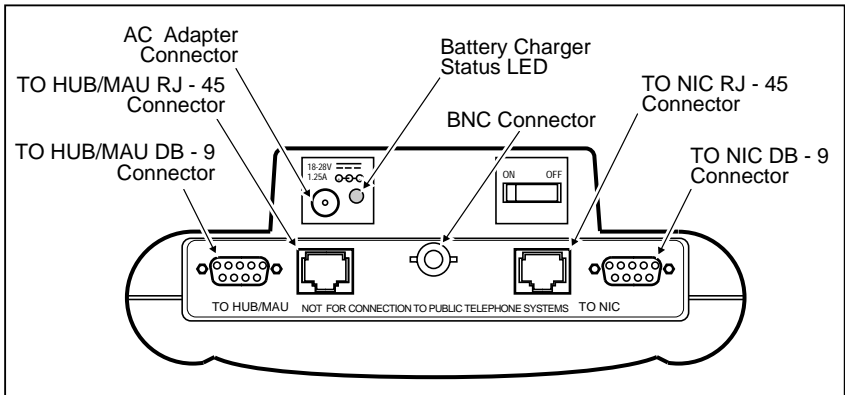

**Figure 1. Network and AC Adapter Connectors (686/685 Shown)**

## ***Changing the Network Interface***

For the Fluke 686 and 685, use the following procedure to change the interface between Ethernet and Token Ring:

1. Press **TAB** from the top-level softkeys.
2. Press **ENTER** **RUN** to confirm the change of interface or press **EXIT** **STOP** to cancel.
3. Wait about 20 seconds for the change of interface to be completed.

## ***User Interface***

The instrument's user interface provides easy access to all functions and consists of the following parts:

- LCD Display
- Keyboard
- Individual and Bargraph LEDs

The user interface is the same for all of the Fluke 68x Series Enterprise LANMeter instruments. They differ only in the way the individual (status) LEDs are labeled and in the name on the instrument. The Fluke 686 and 685 are labeled for both Ethernet and Token Ring functions, the Fluke 683 and 682 have an Ethernet label, and the Fluke 680 has a Token Ring label. Examples of LANMeter instrument labeling are shown in Figures 2 and 4.

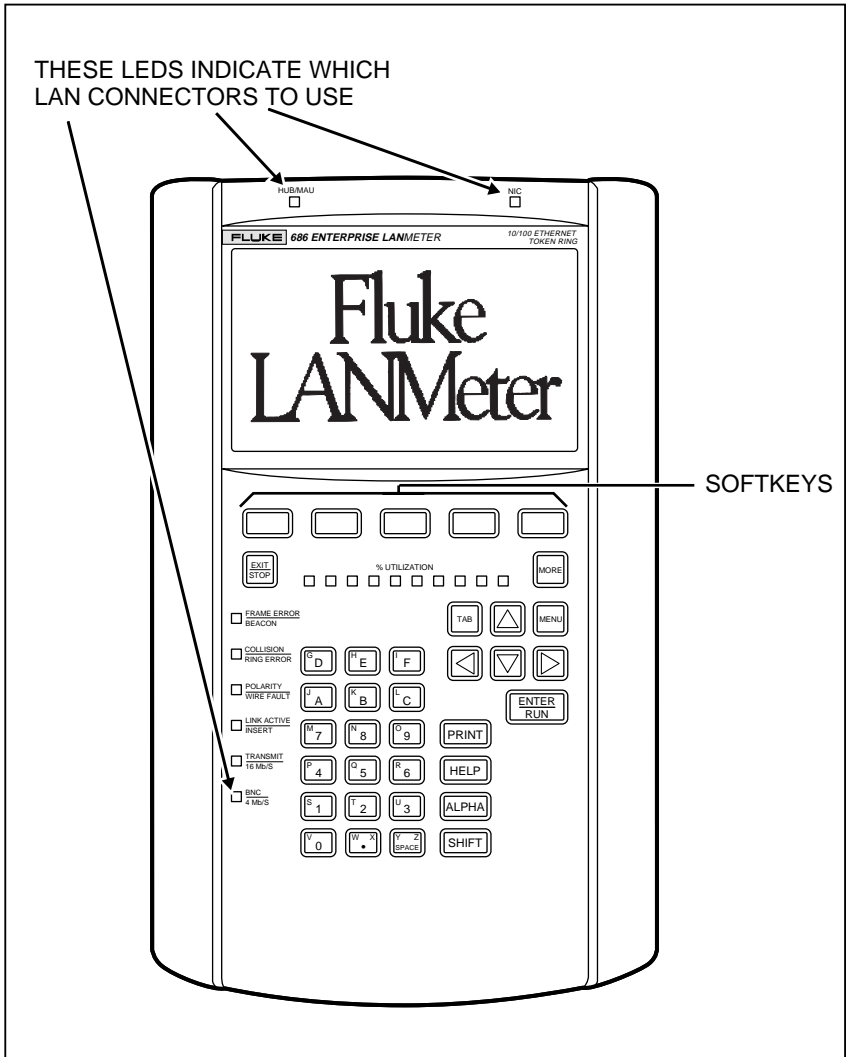

**Figure 2. LANMeter Instrument User Interface (Fluke 686 Shown)**

The instrument softkeys are organized by commonly performed tasks. Tests that are useful for several different tasks are accessible from all relevant modes of operation. The available softkeys depend on which options are enabled (if any) and which interface is selected (Fluke 686 and 685 only).

## LCD Display

The instrument's display consists of a LCD graphic screen for output as shown in Figure 3. The display has the following specific areas for displaying different types of information:

- Work Area
- Softkey Labels
- Status Line

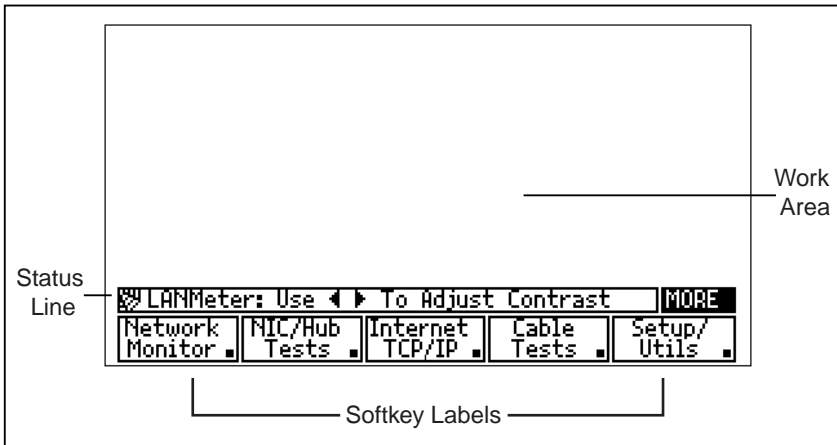

**Figure 3. LCD Display Areas**

Use the **Display Config** softkey to control the screen backlight operation. The **Display Config** softkey is accessed by pressing the **Setup/Utils** softkey and then the **MORE** key. At any time, you can press and release **SHIFT**, then press **ALPHA** to turn the LCD backlight on and off. Refer to the “Display Configuration” section in this manual for more information on controlling the screen backlight.

You can control the display contrast from the top-level (power-on) menu by using **[Left Arrow]** and **[Right Arrow]**. Press **[Left Arrow]** to make the display lighter and press **[Right Arrow]** to make the display darker.

## Work Area

The instrument provides test data and pop-up menus for selecting test and configuration options. If you need to set any of these options, do so before running a test. Pop-up menus cannot be accessed while running a test.

Whenever a procedure tells you to press **MENU**, doing so causes a pop-up menu to appear. To move from one choice to another, press **△** or **▽**. Press **ENTER RUN** to accept a menu choice. Press **EXIT STOP** to close a pop-up menu without making a selection.

You can access a pop-up Test Menu by highlighting a test softkey label and then pressing **MENU**. Select **Configure** and then press **ENTER RUN** to configure the selected test.

Pop-up Configuration Menus are available for most tests. You can access a pop-up Configuration Menu by selecting a top-level softkey, highlighting the desired test softkey label, pressing **MENU**, and selecting the desired action.

## Softkey Labels

The softkey label area is found along the bottom of the display, directly above the five blue softkeys as shown in Figure 3. For each softkey, the label and its associated function changes as you move through the menu system. Figure 5 shows the Ethernet softkey tree and Figure 6 shows the Token Ring softkey tree. The softkey trees are specific to the Ethernet or Token Ring interface, depending on which LANMeter instrument is being used or which mode is selected (Fluke 686 and 685 only). The softkeys show options or operations available within a test.

## Status Line

The instrument displays the status line above the softkey labels as shown in Figure 3. The status line provides information about the state of your instrument or about controlling your instrument. For example, from the top-level softkeys, the status line indicates how to control the screen contrast, as shown in Figure 3.

## Keyboard

The instrument has a custom keyboard (shown in Figure 4). The keyboard consists of the following types of keys:

- Softkeys
- Dedicated keys
- Alphanumeric keys

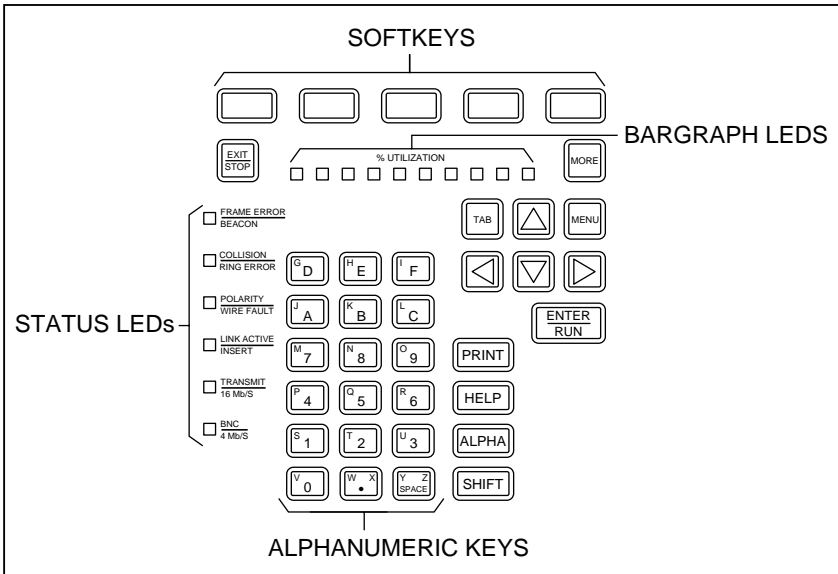

**Figure 4. Keyboard and LEDs (686/685 Shown)**

## Softkeys

Use the instrument softkeys to select functions, to configure tests, and to run tests. The instrument displays softkey labels directly above each softkey. Figure 5 shows the Ethernet softkey tree and Figure 6 shows the Token Ring softkey tree. The softkey trees are specific to Ethernet or Token Ring depending on which instrument is being used or which mode is selected (Fluke 686 and 685 only). Softkeys operate in one of two ways: some access a second level of softkeys and some execute a function. Figures 7 and 8 show the Ethernet and Token Ring top-level softkeys, respectively.





## 68x Series

### Getting Started

---

Use **MORE** to access additional softkeys on the current functional level. The **MORE** key is operational only when the **MORE** label is displayed above the far right softkey label (in the status line) as shown in Figure 3.

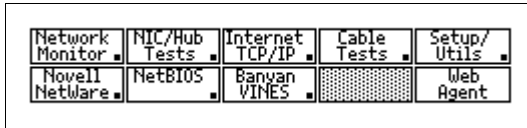

Network Monitor	NIC/Hub Tests	Internet TCP/IP	Cable Tests	Setup/Utils
Novell NetWare	NetBIOS	Banyan VINES		Web Agent

**Figure 7. Ethernet Top-Level Softkeys (Version 9.50)**

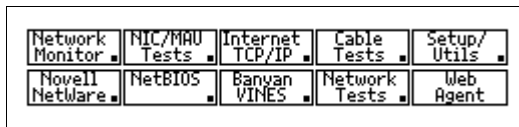

Network Monitor	NIC/MAU Tests	Internet TCP/IP	Cable Tests	Setup/Utils
Novell NetWare	NetBIOS	Banyan VINES	Network Tests	Web Agent

**Figure 8. Token Ring Top-Level Softkeys (Version 9.50)**

The softkey menu structure uses two kinds of softkey labels. The top-level softkeys, with the exception of **Setup/Utils**, access test categories. The small boxes in the lower right-hand corners of the top-level softkey labels indicate that there is a second level of softkeys beneath these softkeys. Pressing one of these softkeys causes the next level of softkeys to be displayed.

A test is selected when its softkey label is highlighted. A highlighted softkey label is displayed in inverse video. In inverse-video, text is displayed in white on a black background. Pressing a highlighted test softkey executes the test.

## Dedicated Keys





Dedicated keys provide access to commonly used functions. The following paragraphs describe each dedicated key:

### *Note*

*Never press and hold down any key while pressing a second key. Always press and release the first key and then press the second key. For example, when you press and release **SHIFT**, the instrument temporarily replaces the **MORE** display label (on the status line) with **SHIFT** and executes the shift function of the next key pressed.*

### ENTER/RUN

Press  in the following situations:

1. Press  to confirm operations or to close some pop-up windows.
2. Press  to run the highlighted test.
3. Press  from the top-level display screen to run Auto Test.
4. Press  while a test is running, or after it has stopped, to zoom-in (or follow the hyperlinks).



The instrument will beep if you press  when there are no additional zoom-in items.

When a test is stopped and displaying its result screen, you must press the **Run Again** softkey, not  to run the test again. For tests that run simultaneous tests (like Network Stats) you can use the available test softkeys to run the desired test.

### MORE







Press  to access an additional row of softkey labels. The instrument displays the MORE label above the far right softkey label when additional softkeys at the same level are available but not displayed.

**EXIT/STOP**

Press  to stop the currently running test, to exit a function (such as Setup or Help), to return to the top-level softkeys, to return up hyperlink paths, to respond to a pop-up menu prompt, or close a pop-up window. Pressing  from a Configuration Menu or Station List Menu saves the changes you have made to non-volatile memory and exits the Menu.







**TAB**

Use  in the following situations:

1. For most tests that display station addresses, press  to switch the address display format from symbolic name, dotted decimal, manufacturer prefix, and hexadecimal. Selecting the **Address Mode** softkey also allows this selection by use of a menu.
2. In tests that display configuration fields and scroll lists on the same screen, such as Station Ping, press  to move between configuration parameters and output results.
3. From the top-level softkeys, press , then press  to switch between the Token Ring and Ethernet interface (Fluke 686 and 685 only).
4. To jump between hyperlink objects press , or press , then  to jump backwards between hyperlink objects.

**PRINT**





Use  in the following situations:

1. Press  to output the graphic image of the current screen to the serial printer port or to the instrument's virtual disk. This depends on the Output Type parameter in File Manager's configuration.
2. To print scrollable lists and ASCII reports, press , **Print All**, or , then . Tests must be stopped to print ASCII information.
3. For some tests, after you stop a test you can press and release , then  to print all of the information collected by the test.

**MENU**

Press  to access the pop-up test and configuration menus.

**UP/DOWN &**

Press , , , and  for display

LEFT/RIGHT ARROW KEYS navigation, screen page up and page down, and field scrolling. Table 3 shows arrow key functions.

**Table 3. Arrow Key Functions**







Key	Function
△	Up one row
▽	Down one row
▷	Adjusts screen contrast (top-level only), screen page down, steps through configuration field selections, or Page Down function in results screens.
◁	Adjusts screen contrast (top-level only), screen page up, steps through configuration field selections, or Page Up function in results screens.
SHIFT, then ▽	Page down
SHIFT, then △	Page up
SHIFT, then ▷	End of list (END)
SHIFT, then ◁	Beginning of list (HOME)

**SHIFT**

Press **SHIFT** to access extended functions and to enter a secondary character from an alphanumeric key. When you press and release **SHIFT**, the instrument temporarily replaces the **MORE** display label with **SHIFT** and executes the shift function of the next key pressed. Press and release **SHIFT** each time you want to access the shift function of a key. For an example, refer to the “Alphanumeric Keys” section.

ALPHA

Press  in the following situations:

1. Press  to enter a secondary character from an alphanumeric key. These secondary characters are the same color (orange) as the lettering on the ALPHA key. When you press and release , the instrument temporarily replaces the **MORE** display label with **ALPHA** and executes the Alpha function of the next key pressed. After pressing , the orange keyboard characters are active. Press and release  each time you want to access the Alpha function of a key. For an example, refer to the “Alphanumeric Keys” section.
2. Press and release  and then press  to turn the screen backlight on and off. Refer to the “Display Configuration” section in this manual for more information on controlling the screen backlight.

HELP



Use  to access information on the highlighted test. Use the following procedure to obtain help on any test:



*Note*

*You must stop all tests prior to using .*







1. Select the desired test category.
2. Highlight the desired test softkey.

The exact steps required to highlight a test softkey depends on which test you want to run. The first test is automatically highlighted. Otherwise, you either press the test softkey once or press , then press the test softkey once (if there is a second row of tests).

3. Press .
4. Use the arrow keys (as shown in Table 3) and the **Prev Page** and **Next Page** softkeys to move around in the help text.
5. Press  to exit the Help System.

- (period key) Use  in the following situations:
    1. Use as a period when entering alpha characters, such as a station list name.
    2. Press  to move from one address octet to the next for editing IP addresses.
- SPACE Press  to access configuration choices of the selected configuration field or to bring up the Station List when an address is selected.

## Alphanumeric Keys

You can enter the numbers 0 through 9, the letters A through F, the period, and the SPACE directly from the keyboard (also called base keys). For example, press and release  to enter a space. To enter the letters **G** through **W** and **Y**, press and release , then press the correct base key. For example, press and release , then press  to input the character **Y**. To enter the letters **X** and **Z**, press and release , then press the correct base key. For example, press and release , then press  to input the character **Z**. Figure 9 shows the Alphanumeric Keys.

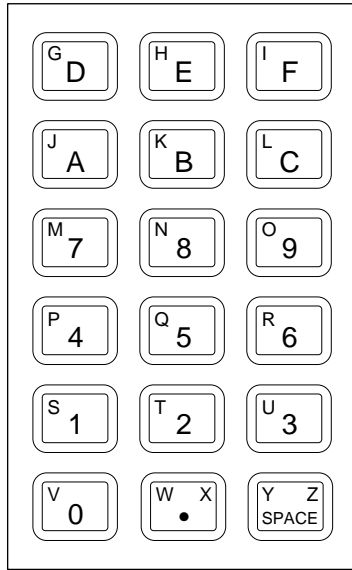

**Figure 9. Alphanumeric Keys**

The following procedure shows how to enter the string **LAZY 8**:

1. Press and release **ALPHA**, then press **L**.
2. Press **A**.
3. Press and release **SHIFT**, then press **Z**.
4. Press and release **ALPHA**, then press **Y**.
5. Press **Y SPACE Z**.
6. Press **8**.

## LED Indicators

The instrument LEDs include both status (individual) and bargraph LEDs that indicate important network conditions. Figure 4 shows the status and bargraph LEDs. You can use these LED indicators for quick problem isolation. The Fluke 686 and 685 individual LEDs have two sets of labels, one for Ethernet (the top label) and one for Token Ring (the bottom label). The instrument also has two individual LEDs to indicate which network connector to use, what Ethernet speed (686 and 683 only), and one LED to indicate battery charger status. The following sections describe the meaning of these LEDs:

- Utilization Percentage Bargraph
- Frame Error/Beacon
- Collision/Ring Error
- Polarity/Wire Fault
- Link Active/Insert
- Transmit/16 Mb/s
- BNC/4 Mb/s
- HUB/MAU
- NIC
- Battery Charger Status

### Utilization Percentage Bargraph

Utilization Percentage bargraph LEDs show the instantaneous network utilization percentage. Each LED represents 10% utilization on the network up to a total of 100% utilization when all 10 LEDs are lit. The more LEDs that the instrument lights, the higher the network utilization.



When the instrument first inserts into a ring, the utilization LED's will briefly light while the instrument performs its Lobe Test.

### Frame Error/Beacon



The red FRAME ERROR LED is on when the instrument detects a jabber frame (a frame with greater than 1518 bytes), a short frame (one with less than 64 bytes), or a frame with a bad frame check sequence.

## 68x Series

### Getting Started

---



The red BEACON LED is on when the instrument detects a beacon frame on the network or when it transmits a Beacon frame. If this LED is on continuously, your ring is in a beaconing state. Manual intervention is usually required to recover a ring that has been in a beaconing state for more than a minute.

### Collision/Ring Error



The yellow COLLISION LED is on when the instrument detects a late, a local, or a remote collision. Local and Remote collisions are not reported on 100 Mbps networks.



The yellow RING ERROR LED is on when the instrument detects any kind of ring recovery frame on the network, such as soft error, ring purge, claim token, or when the neighbor notification is incomplete.

### Polarity/Wire Fault



The red POLARITY LED is on when the instrument detects reversed polarity on the receive link for a 10BASE-T connection. The state of the Polarity LED is only valid if the instrument is connected to a hub.



The red WIRE FAULT LED is on when the instrument detects a fault in the lobe wiring between it and the MAU.

### Link Active/Insert



The green LINK ACTIVE LED is on when the instrument receives the link pulse from an Ethernet hub.



The green INSERT LED is on when the instrument inserts into the ring or, in the Expert-T mode, when the attached station is inserted into the network through the instrument.

### Transmit/16 Mb/s



The yellow TRANSMIT LED is on when the instrument transmits a frame.



The yellow 16 Mb/s LED is on when the instrument detects the ring speed as 16 Mbps or, if doing a NIC Autotest, when it detects the NIC speed as 16 Mbps.

## BNC/4 Mb/s

- The green BNC LED is on to indicate that you should connect to the BNC connector. The BNC LED will flash when the instrument's BNC connector is terminated internally in 50 ohms.
- The green 4 Mb/s LED is on when the instrument detects the ring speed as 4 Mbps or, if doing an NIC Autotest, when it detects the NIC speed as 4 Mbps.



## HUB/MAU

The **HUB/MAU** LED is located near the **TO HUB/MAU** connectors. The instrument turns on the green **HUB/MAU** LED to identify the correct port for attaching a cable to run the selected test. The LED flashes green/blue on the Fluke 686 and 683 instruments. The Fluke 680 labels this LED as **MAU**, the Fluke 683 and 682 label this LED as **HUB**, and the Fluke 686 and 685 label this LED as **HUB/MAU**.

For Fluke 686 and 683 instruments only, the **HUB/MAU** and **HUB** LEDs are dual-color (green/blue) and have two functions: first, to identify the correct port for attaching the cable to run the selected test and second, to identify the Ethernet speed. When the LANMeter instrument's Ethernet Speed is configured for 100 Mbps, the LED is blue and when it is configured for 10 Mbps, the LED is green. When you configure the instrument's Ethernet Speed for Auto Detect, the LED flashes green/blue until a network connection is made. The LED turns on solid blue when connected to a 100 Mbps network or turns on solid green when connected to a 10 Mbps network.

## NIC

The instrument turns on the green **NIC** (Network Interface Card) LED, located near the **TO NIC** connectors, to identify the correct port for attaching a cable to run the selected test. The LED flashes green/blue on the Fluke 686 and 683 instruments.

For Fluke 686 and 683 instruments only, the **NIC** LED is dual-color (green/blue) and has two functions: first, to identify the correct port for attaching the cable to run the selected test and second, to identify the Ethernet speed. When the LANMeter instrument's Ethernet Speed is configured for 100 Mbps, the LED is blue and when it is configured for 10 Mbps, the LED is green. When you configure the instrument's Ethernet Speed for Auto Detect,

the LED is blue and stays blue when connected to a 100 Mbps network or changes to green when connected to a 10 Mbps network.

## Battery Charger Status

The red Battery Charger Status LED is located next to the AC Adapter input connector. Figure 10 shows the Fluke 686/685, Figure 11 shows the Fluke 683/682, and Figure 12 shows the Fluke 680. The Battery Charger Status LED has several on/off patterns to indicate the charging state of the battery. The Battery Charger Status LED is off when the AC Adapter is disconnected.

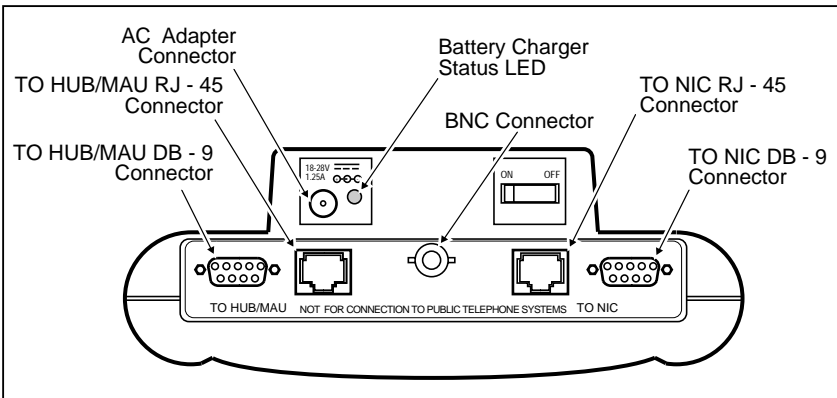

**Figure 10. Network and AC Adapter Connectors (686/685 Shown)**

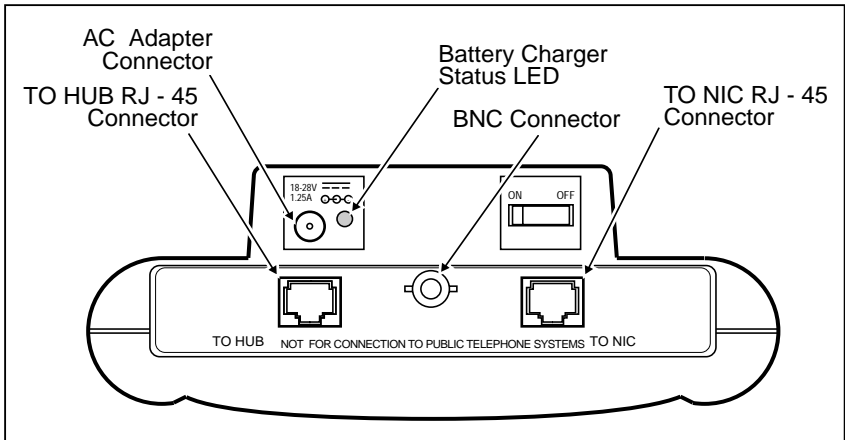

**Figure 11. Network and AC Adapter Connectors (683/682 Shown)**

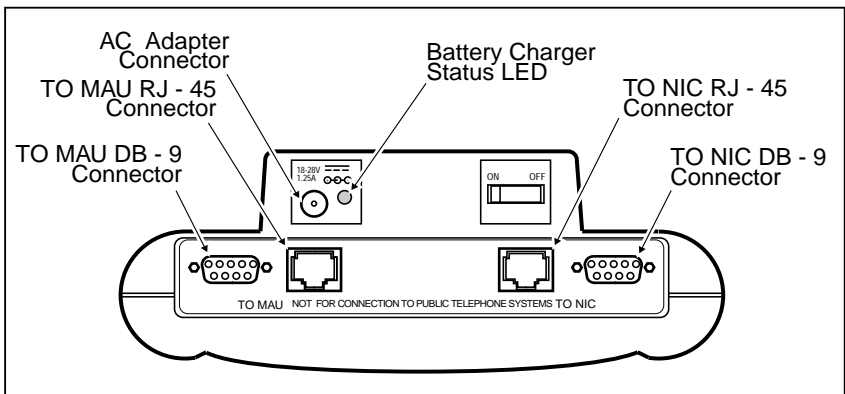

**Figure 12. Network and AC Adapter Connectors (680 Shown)**

The instrument has a fast charging capability to completely charge the battery in about 2 1/2 hours. You can use a fully charged battery for about 3 hours. Continuous use of the screen backlight reduces this time by about 30%.

You can leave the AC Adapter connected after the battery is completely charged. It continues to trickle charge the battery and the Battery Charger Status LED remains in the “charge complete” pattern.

## 68x Series

### Getting Started

---

The instrument replaces the status line label with the battery icon when the battery requires charging. Table 4 shows the battery charger status LED on/off patterns. Refer to the “Maximizing Battery Life” section in Appendix C of the *Users Manual*, for more information on the battery.

**Table 4. Battery Charger Status LED**

LED State	Meaning
OFF	External power is disconnected or battery is absent.
ON Continuously	Batteries are being fast-charged.
Fast (4 Hz) Blinking	Battery charging has been completed; trickle charging continues.
Slow (0.6 Hz) Blinking	Batteries are not within the temperature and voltage range for fast charging. Trickle charging is occurring.

## Setup/Utils

The instrument comes from the factory configured with default values. You can configure test and setup parameters as required by your network or test conditions. Refer to the appropriate section of the *Users Manual* for specific information on test configurations. The following sections contain configuration information accessible with the **Setup/Utils** softkey:

- Network Configuration
- Station List
- Manage Options
- File Manager
- Terminal Emulator
- System Information
- Update Software
- Time and Date
- Display Configuration
- Self Test

Figure 13 shows the Setup/Utils softkeys.

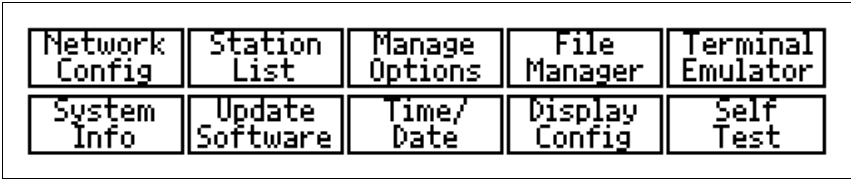

**Figure 13. Setup/Utils Softkeys (Version 9.50)**

Any configuration changes that you make are automatically saved to non-volatile memory when you press **EXIT STOP**. You can undo configuration changes before you press **EXIT STOP** by selecting **Cancel Changes** in the pop-up Configuration Menu, and pressing **ENTER RUN**. Figure 14 shows a Configuration Menu.

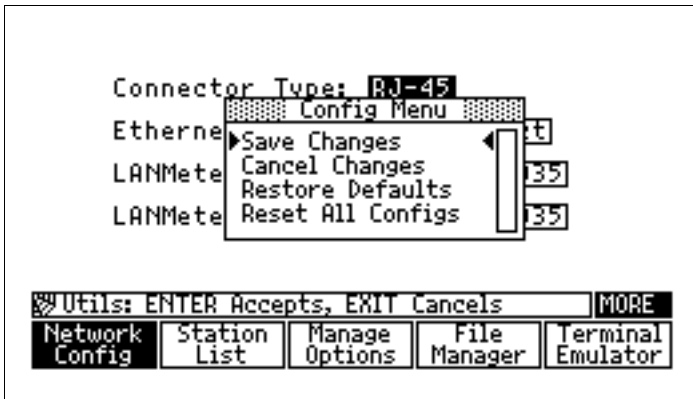

**Figure 14. Configuration Pop-up Menu**

You can use the factory defaults for the selected Setup/Utils category by selecting **Restore Defaults**, and then pressing **ENTER RUN** from the Configuration Menu (when available). The defaults are then saved to non-volatile memory when you press **EXIT STOP** to exit the Setup/Utils category.

You can reset all Setup/Utils categories and test configurations by selecting **Reset All Configs**, then pressing **ENTER RUN** from the Configuration Menu. Resetting all configurations does not erase saved Station Lists.

*Note*

For the Fluke 686 and 685, the **Reset All Configs** option has no effect on the opposite interface mode. That is, selecting the **Reset All Configs** option while in the Ethernet interface does not reset configuration settings in the Token Ring interface, and vice versa.

## **Network Configuration**

Press the top-level **Setup/Utils** softkey, and the Network Configuration screen is automatically selected. Configure the following Ethernet or Token Ring parameters to your specific testing requirements. The default parameters are underlined.

### *Ethernet*

#### **Caution**

**Always configure the Fluke 686 and 683 LANMeter instrument's Ethernet Speed parameter to Auto Detect when you are unsure whether you are attaching to a 10 Mbps or to a 100 Mbps Ethernet network.**

**Do not configure the LANMeter instrument for 100 Mbps and then attach it to a 10 Mbps network. The presence of the 100 Mbps link pulse on a 10 Mbps network effectively brings down the network by preventing all stations from transmitting.**

**Configuring the LANMeter instrument to 10 Mbps and then attaching it to a 100 Mbps network causes erroneous results (such as excessive collisions) to be reported.**



- Connector Type as RJ-45, or BNC
- Ethernet Speed as Auto Detect, 10 Mbps, or 100 Mbps (for RJ-45 only and on Fluke 686 and 683 instruments only)
- LANMeter MAC as Predefined or user definable

The Auto Detect Ethernet Speed selection puts the instrument in a mode where it automatically detects the network speed and sets its configuration to match that speed. If the instrument is configured for Auto Detect and is then connected to an auto-speed port, it automatically negotiates for a speed of 100 Mbps.

The LANMeter MAC is the MAC address used by the instrument while it is inserted in the network.

## *Token Ring*

### **Caution**

**Selecting an incorrect ring speed will cause the ring to beacon.**



- Connector Type as DB-9, or RJ-45
- Ring Speed as Auto, 4 Mbps, or 16 Mbps
- LANMeter MAC as Predefined or user definable
- Beacon Detect as Enable or Disable

The Auto ring speed selection puts the instrument in a mode where it automatically detects the network speed and sets its configuration to match that speed. The Auto ring speed selection should not be used when using smart MAUs such as the IBM Controlled Access Unit (CAU), Lobe Attachment Modules, or the Madge SmartCAU.

The Beacon Detect field enables or disables the Beacon pop-up window to appear when a beacon frame is detected.

## ***Station List***

A Station List is a list of symbolic station names (optional) and their associated network addresses, which can be used in certain instrument tests. Refer to the *Users Manual*, “Station List” chapter for more information on using Station List.

## ***Manage Options***

Press the **Manage Options** softkey to enable software options such as SwitchWizard and WideAreaWizard. Refer to the specific chapter in the *Users Manual* for information on enabling any particular option. You can run Manage Options to list the enabled options. The number of trial uses remaining for software options (if any) is also listed.

## ***File Manager***

You can use File Manager to print, email, import, export, rename, or delete the following types of saved files:

- Reports and Graphics
- Data Logs
- Station Lists

Press **Setup/Utils** and then press **File Manager** twice to access File Manager. Refer to the *Users Manual*, “File Manager” chapter for more information on File Manager functions. File Manager functions are also available via the Web Agent measurement. Refer to the *Users Manual*, “Web Agent/WebRemote Control” chapter for more information.

## **Terminal Emulator**

Terminal Emulator is a feature supported in the Fluke Enterprise LANMeter (68x Series) instrument Software Version 9.50, and later, that gives you the ability to use your LANMeter instrument to inspect and configure network devices. Refer to the *Users Manual*, “Terminal Emulator Option” for more information.

## **System Information**

Pressing the top-level **Setup/Utils** softkey followed by the **MORE** key will display the Sys Info screen. The **System Info** softkey will be highlighted. You can view the instrument software and hardware revision levels, the LANMeter instrument default MAC address (for the Fluke 686 and 685, both Ethernet and Token Ring MAC addresses are shown) and whether the backlight option is installed on your instrument.

## **Update Software**

As new software becomes available, the instrument can be updated by using an IBM-compatible computer and a Fluke supplied software update disk. Refer to the “Software Update” section in Appendix D of the *Users Manual*, and the documentation provided with the Fluke software update disk for information on updating the LANMeter instrument software.

## **Time and Date**

Use the following procedure to set the Time and Date:

1. Press the top-level **Setup/Utils** softkey.
2. Press **MORE** and then the **Time/Date** softkey.
3. Enter the current date and time using the numbers 0 through 9 and move between fields using **TAB**, **▽**, **△** or **ENTER/RUN**.
4. Press **EXIT/STOP** to save your changes to non-volatile memory and to return to the top-level softkeys.

## ***Display Configuration***

The Display Configuration screen allows you to configure the automatic screen backlight. The following parameters can be configured for Display Configuration (the defaults are underlined):

- Backlight Timeout as 1 minute, 5 minutes, or 10 minutes.
- Auto Backlight as Disable or Enable.

Use the following procedure to configure the automatic screen backlight:

1. Press the top-level **Setup/Utils** softkey.
2. Press  and then the **Display Config** softkey.
3. Use  and  to set the Backlight Timeout field to 1, 5, or 10 minutes.
4. Press  to select the Auto Backlight field.
5. Press  or  to enable or disable the backlight function.

After you set the Auto Backlight field to **Enable**, the screen backlight turns on for the configured timeout period and then turns off. You can then turn on the backlight again by pressing any key. While the backlight is on, you can press and release  and then press  to turn off the backlight. Turning off the backlight saves battery power when the instrument is not plugged in using the AC adapter.

After you set the Auto Backlight field to **Disable**, the screen backlight turns off after the configured timeout period. While the backlight is off, you can press and release  and then press  to turn on the backlight for the configured timeout period.

## **Self-Test**

The first time you turn on your LANMeter instrument on a particular day, the instrument automatically performs extensive power-on self tests. All subsequent power-on self tests for that day are less extensive and completed in much less time.

You can verify correct operation of the instrument manually by using the following procedure:

1. Press the top-level **Setup/Utils** softkey.
2. Press **[MORE]** and then the **Self Test** softkey.
3. Select the appropriate self-test and press **[ENTER RUN]**.

You can run the following self-tests on the LANMeter instrument:

1. LANMeter Self Test
2. LANMeter Keyboard Test
3. LANMeter Serial Test
4. 100 MHz Cable Remote Test

## **Self Test**

When running the LANMeter Self Test, disconnect all cables from the instrument **TO MAU** and **TO NIC** connectors. Verify that all tests pass. The instrument displays the message **Passed** for each test to indicate proper operation. These self tests are more extensive than the power-on self tests.

If the instrument reports a failure, perform the steps in the “Service Center Repair” section of Appendix C “Maintenance” of the *Users Manual*.

## **Keyboard Test**

When running the LANMeter Keyboard Test, manually perform the steps displayed on the screen and verify that the test passed. The five softkeys shown in Figure 4 are referred to as F1 through F5 with F1 being the leftmost softkey and F5 the rightmost.

### *Serial Test*

When running the LANMeter Serial Test, attach a loopback connector to the **Serial** connector on the lower left-hand side of the instrument. To make a loopback connector, take a female DB-9 connector and connect jumpers between pins 2 and 3 and between pins 6 and 7. Verify that all tests pass.

### *100 MHz Cable Remote Test*

This test requires the optional 100 MHz Cable Remote. When running the 100 MHz Cable Remote Test, attach the supplied ScTP Cat 5 Patch Cable between the LANMeter instrument's **TO HUB/MAU** (686/685) or **TO Hub** (683/682) and the 100 MHz Remote. Verify that all tests pass.

## **Attaching Cables**

You attach cables to the instrument in one of the following three configurations. The configuration that you use depends on the test you want to run.

- TO MAU, TO HUB, or BNC Connection
- TO NIC Connection
- Expert-T Autotest Connection

The instrument lights the **MAU** (or **HUB**) and/or **NIC** LEDs on the top-front of the instrument to indicate which of the LAN connectors you should use for the selected test. The Fluke 680 has a **MAU** LED, the Fluke 683 and 682 have a **HUB** LED, and the Fluke 686 and 685 have a **HUB/MAU** LED. Figure 2 shows these LEDs on the instrument's user interface.

On the Fluke 686, 685, and 680 there are two **TO MAU** (or **TO HUB**) and two **TO NIC** connectors, as shown in Figure 1. Each pair consists of an RJ-45 and DB-9 type connector that are connected in parallel. Use only one **TO MAU** or **TO NIC** connector at a time. If your network uses BNC connectors, use the BNC connector as shown in Figure 1.

## **Warning**

**Do not connect the instrument to the public telephone system. If you do, damage can occur to the LANMeter instrument.**

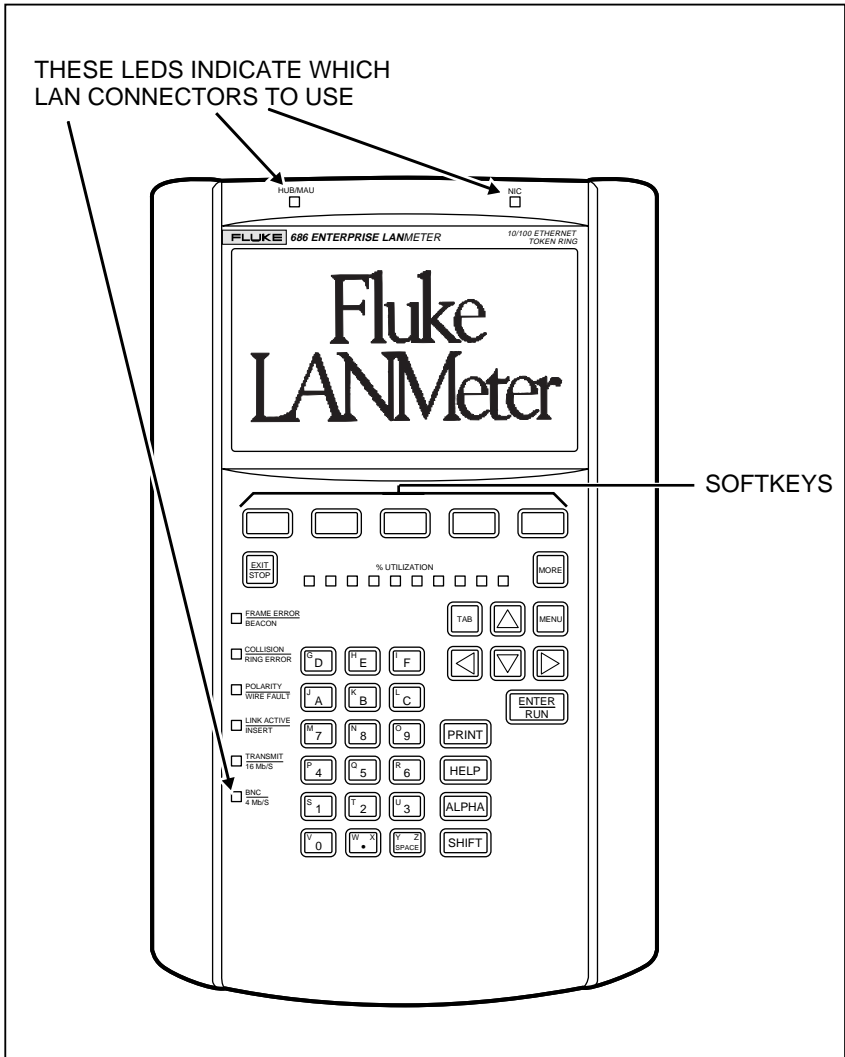

**Figure 15. User Interface (Fluke 686 shown)**

### *TO MAU, TO HUB, or BNC Connection*

Most instrument tests require connecting only to the **TO MAU** (or **TO HUB**) or **BNC** connector. Figure 16 and Figure 17 show the LANMeter instrument connected to the network using the **TO HUB/MAU** and **BNC** connector, respectively. Use one of the **TO MAU** (or **TO HUB**) or **BNC** connectors for all cable tests. The Fluke 686 and 685 have **TO HUB/MAU** connectors and a BNC connector, the Fluke 683 and 682 have a **TO HUB** connector and a BNC connector, and the Fluke 680 has **TO MAU** connectors.

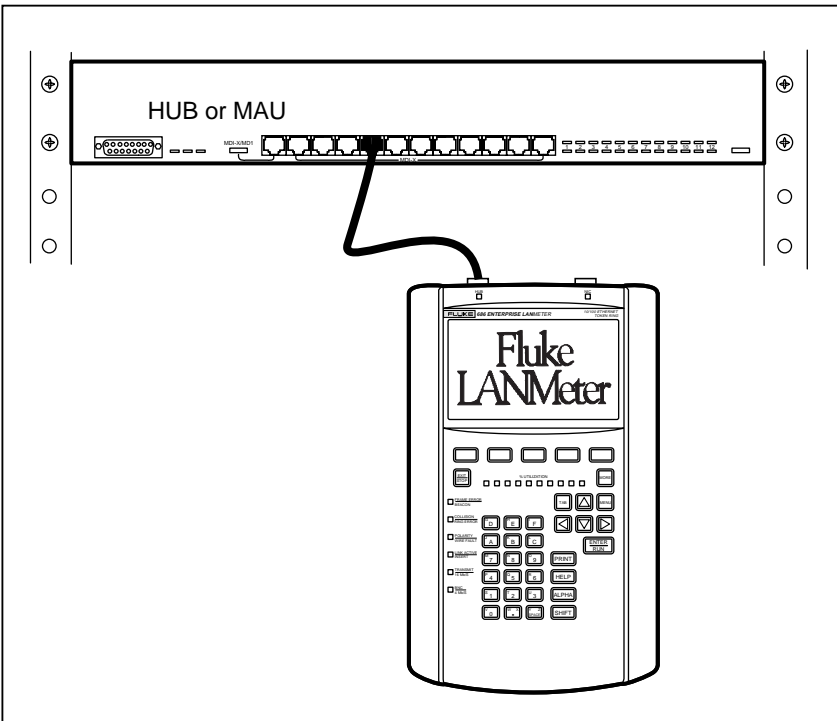
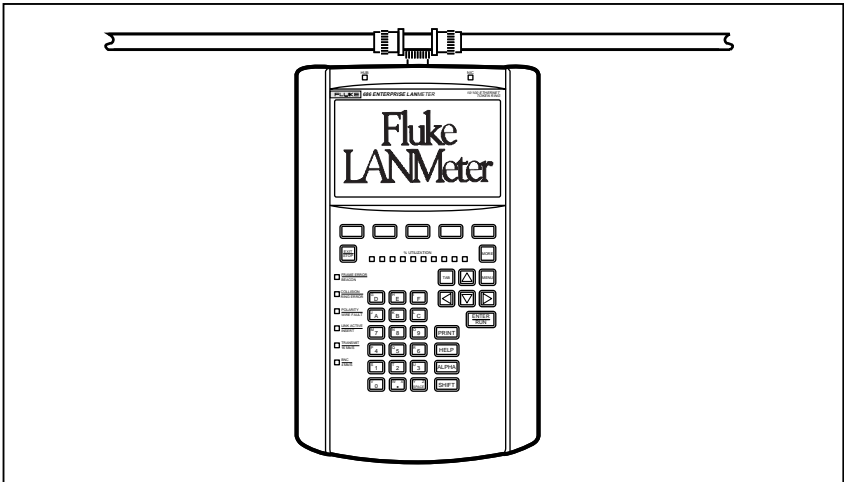

**Figure 16. TO HUB/MAU Connection Using RJ-45 Connector**



For 100BASE-TX or 10BASE-T cabling systems, select RJ-45 as the connector type under Network Configuration, which is accessed by pressing the **Setup/Utils** softkey. You can attach the instrument at the hub (a central connecting point in a star-wired network) or at the station. When connecting at the hub, use a cable connected between the hub and the instrument's **TO HUB** connector. When connecting at the station, disconnect the station's cable from the station and attach it to the instrument's **TO HUB** connector. Figure 16 shows the instrument connected to a hub.

For a ThinLAN connection, select BNC as the connector type under Network Configuration. Attach the instrument at the T-connector. Figure 17 shows a BNC connection.



**Figure 17. BNC Connection**

For an AUI connection, select RJ-45 as the connector type under Network Configuration and use a 100BASE-TX-to-AUI or 10BASE-TX-to-AUI adapter.

## 68x Series

### Getting Started

---



For STP cabling systems, select DB-9; for UTP cabling systems, select RJ-45 as the connector type under Network Configuration. You can attach the instrument at the Multi-station Access Unit (MAU) or at the station. When connecting at the MAU, use a lobe cable connected between the MAU and the instrument's **TO MAU** connector. When connecting at the station, disconnect the station's lobe cable from the station and attach it to the instrument's **TO MAU** connector. Figure 16 shows the instrument connected to a MAU.

#### *Note*

*In Token Ring networks and especially for the Phase Jitter test, it is important to set the connector type correctly. Failure to do so could result in excessive soft errors, ring purges, and/or beaconing. This is due to the instrument's internal termination being improperly set for your network. The DB-9 setting provides a 150 ohm termination and the RJ-45 setting provides a 100 ohm termination. Refer to the "Running a Test" section in this manual for information on configuring the Connector Type parameter.*

## *TO NIC Connection*

Use the **TO NIC** connector for the NIC Autotest as shown in Figure 18.

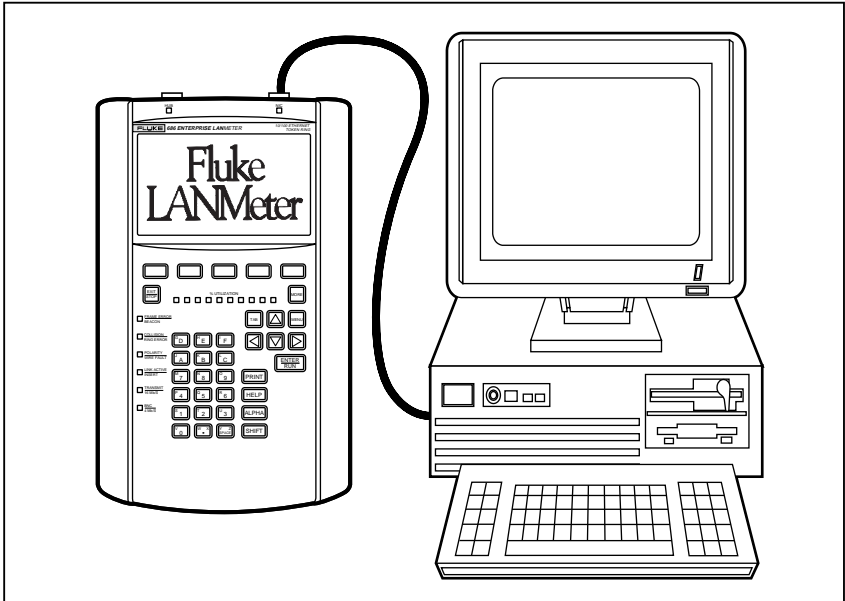

**Figure 18. TO NIC Connection**

- For 100BASE-TX or 10BASE-T networks, connect the NIC card to the instrument's **TO NIC** connector. Refer to the section on the test that you are going to run for additional connection information.

For ThinLAN coaxial networks, the instrument and the NIC under test must be the only devices on the network. The connection should be a relatively short coaxial cable (less than 20 feet) with a single terminator and T connector at the network interface card. The instrument automatically terminates its end of the cable for this test.

### *Expert-T Autotest Connection*

Use both the **TO MAU** (or **TO HUB**) and **TO NIC** connectors for the Expert-T Autotest as shown in Figure 19.

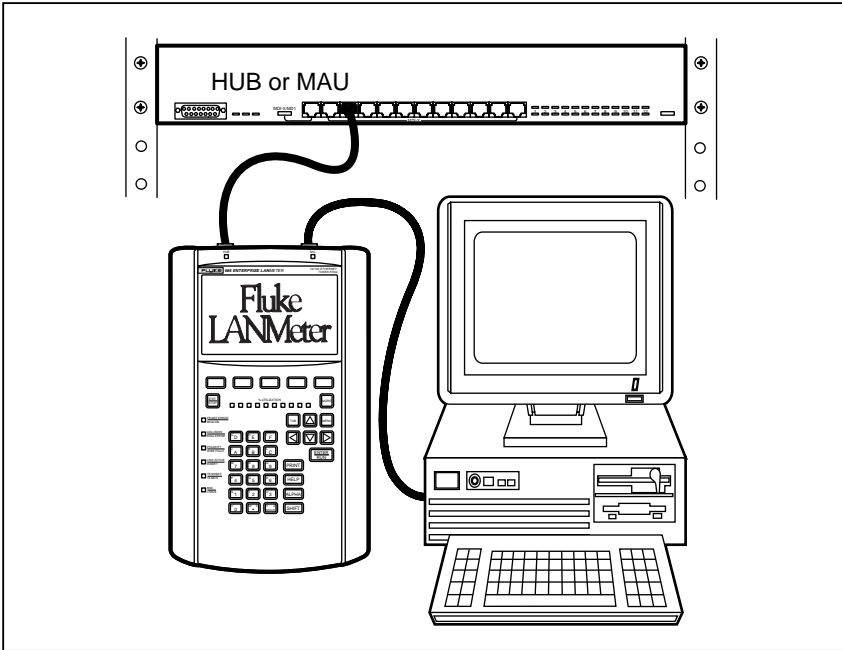

**Figure 19. Expert-T Autotest Connections**

## **Running a Test**

The instrument displays the top-level softkeys after it is turned on. The **MORE** label above the **Setup/Utils** softkey label indicates that there are additional softkeys on this level. Press **MORE** to access the second row of softkeys. Figure 7 shows the instrument's Ethernet top-level softkeys and Figure 8 shows the instrument's Token Ring top-level softkeys.

Use the following general procedure to run and stop a test.

1. Configure the instrument as required for your Ethernet or Token Ring network. Verify that the Connector Type and the network speed parameters are correct under Network Configuration, which is accessed by pressing the **Setup/Utils** softkey from the top-level softkeys.
2. Select the desired test category by pressing the appropriate top-level softkey. (Figures 5 and 6 show the LANMeter instrument's softkey trees.)
3. Highlight the desired test to run.

The exact steps required to highlight a test depend on which test you want to run. The first test is automatically highlighted. Otherwise, you either press the test softkey once or press **MORE**, then press the test softkey once (if there is a second row of tests).

4. Attach the appropriate cables. Refer to the previous "Attaching Cables" section for more information.
5. Press the **MENU** softkey and select **Configure** to configure the test that you are about to run unless you want to use the default settings. Some tests do not have configurable parameters.
6. Press the test softkey a second time or press **ENTER RUN** to run the test.
7. Observe the test results.
8. Press **EXIT STOP**. (Some tests stop automatically and do not require pressing **EXIT STOP**.)

## ***Auto Test***

You can perform a quick analysis of the health of your network by running Auto Test. After setting up your LANMeter instrument, configuring it and connecting it to the network, as described in previous sections of this manual; press  from the top-level softkey menu. This will automatically configure the IP address of the LANMeter instrument using DHCP and initiate the Segment Discovery test. Refer to the *Users Manual*, “Testing TCP/IP Networks” chapter for more information on Auto Test, IP Auto Config and Segment Discovery.

## Overview of Tests

Use the information in the following tables to help you select a test to accomplish a particular task. Tables 5 through 15 show the appropriate test category and test to use for the desired task. The test category is the same as its top-level softkey.

**Table 5. Cable and Media Information and Problems**

To Do the Following Task	Use this Test	Under this Test Category
Verify a 100 MHz Cat 5 Cable installation. #	Cable Autotest #	Cable Tests
Measure cable lengths.	Cable Scan	Cable Tests
Find and isolate cable and connector problems.	Cable Scan	Cable Tests
Verify coax cable is terminated correctly.	DC Continuity*	Cable Tests
Map the physical layout of your network.	Cable Identifier	Cable Tests
Identify incorrect cable to connector wiring.	Wire Map, NEXT	Cable Tests
Determine the NVP of an unknown cable type.	Find NVP	Cable Tests
* Available only for Ethernet # Requires the 100 MHz Cable Test Option		

**Table 6. Ethernet NIC and Hub Problems**

To Do The Following Task	Use This Test	Under this Test Category
Verify that a hub can successfully transmit and receive traffic.	Hub Autotest	NIC/Hub Tests
Test a NIC's link pulse, transmit polarity, and transmit level. Identify the protocol a NIC is running.	NIC Autotest	NIC/Hub Tests
Automatically check hub and NIC.	Expert-T Autotest	NIC/Hub Tests

**Table 7. Ethernet Performance Information**

<b>To Do The Following Task</b>	<b>Use This Test</b>	<b>Under this Test Category</b>
Identify the types and sources of collisions and errors.	Error Statistics	Network Monitor
Measure network utilization, collision, error, and broadcast rates.	Network Statistics	Network Monitor
Determine the affect of added traffic on the collision and error rate.	Network Statistics with the Traffic Generator operating in the background.	Network Monitor

**Table 8. Ethernet and Token Ring Network Information**

<b>To Do The Following Task</b>	<b>Use This Test</b>	<b>Under this Test Category</b>
Identify the protocols running on the network.	Protocol Mix	Network Monitor
Determine the transmitting stations and their protocols.	Protocol Mix	Network Monitor
Identify stations (by MAC address) sending and receiving the most traffic.	Top MAC or MAC Matrix	Network Monitor
Determine the source and type of broadcasts.	Top MAC (Top Broadcasts)	Network Monitor
Test bridge, hub and router frame capacity.	Traffic Generator	Network Monitor
Test traffic patterns for switch placement.	MAC Matrix	Network Monitor
Discover the source of bottlenecks on Cisco ISL trunk lines.	Protocol Mix	Network Monitor

**Table 9. Token Ring Network Information**

<b>To Do The Following Task</b>	<b>Use This Test</b>	<b>Under this Test Category</b>
List stations currently attached to the ring. Identify the active monitor. Map stations to lobe cables.	Ring Stations	Network Monitor
Determine if the network is operating efficiently.	Network Statistics	Network Monitor
Identify and locate a noisy lobe cable or network interface card. Determine the source and causes of soft errors.	Error Statistics	Network Monitor
Determine the route, maximum frame size, and number of hops between stations across Token Ring source routing bridges. Verify network connectivity across Token Ring source routing bridges.	Station Ping	Network Tests
Identify stations performing Token Ring functions, such as Ring Error Monitor.	Adapter Status	Network Tests
Remove a station from the ring.	Remove Station	Network Tests
Troubleshoot a beaconing ring.	Network Statistics	Network Monitor
Determine ring speed as 4 Mbps or 16 Mbps.	Network Statistics configured for AUTO speed in Network Config	Network Monitor
Calculate the Adjusted Ring Length (ARL). Measure the Token Rotation Time.	Token Rotation Time	Network Monitor
Quantify what percentage of traffic is ring maintenance.	Protocol Mix	Network Monitor
Determine if your network is operating on the secondary (backup) path.	Token Rotation Time	Network Monitor
Verify that a lobe cable can pass 4 Mbps and/or 16 Mbps traffic.	Lobe Test	NIC/MAU Tests
Measure the relative noise level on your network.	Phase Jitter	Network Tests

**Table 10. Token Ring NIC and MAU Problems**

<b>To Do The Following Task</b>	<b>Use This Test</b>	<b>Under this Test Category</b>
Identify a stuck MAU port or verify MAU operation.	MAU Autotest & MAU Reset	NIC/MAU Tests
Monitor the NIC insertion process.	NIC Autotest	NIC/MAU Tests
Verify that an NIC can insert into a MAU.	Expert-T Autotest	NIC/MAU Tests
Determine why a NIC cannot insert into a network.	Expert-T Autotest	NIC/MAU Tests

**Table 11. Novell NetWare Network Information**

<b>To Do The Following Task</b>	<b>Use This Test</b>	<b>Under this Test Category</b>
Verify network connectivity across a NetWare router.	NetWare Ping	Novell NetWare
List nearest server and frame type. List of all servers. List of file servers.	Server List	Novell NetWare
Identify stations (by IPX network address) sending and receiving the most traffic.	Top NetWare (Top Senders and Top Receivers)	Novell NetWare
Load balance NetWare traffic for segments and rings.  Determine the percentage of traffic that is routed.	Routing Analysis	Novell NetWare
Identify overloaded servers.  Determine which stations are placing the largest demand on servers.	NetWare Stats (File Statistics and Packet Statistics)	Novell NetWare
Determine the percentage of traffic that is burst mode.	NetWare Stats (Packet Statistics)	Novell NetWare
Determine the local IPX network number.	Server List, Routing Analysis, NetWare Stats (File Statistics and Packet Statistics)	Novell NetWare
Identify the encapsulation types used.	Server List Protocol Mix NetWare Ping	Novell NetWare Network Monitor Novell NetWare

## 68x Series

### Getting Started

---

**Table 12. TCP/IP Configuration and Performance**

<b>To Do the Following Task</b>	<b>Use This Test</b>	<b>Under this Test Category</b>
Automatically have the LANMeter instrument assist in its own IP configuration.	IP Auto Config	Internet TCP/IP
Discover IP configuration of attached network.	Segment Discovery	Internet TCP/IP
Analyze a troublesome IP host.	Scan Host	Internet TCP/IP
Analyze the path through the network that an IP session would follow.	Trace Route	Internet TCP/IP
Focus on host identification, configuration and attached interface health and performance.	Internet Toolkit	Internet TCP/IP
Identify Duplicate IP Addresses.	Segment Discovery Scan Host	Internet TCP/IP
Monitor the status of important user designated IP devices.	Segment Discovery (Key Devices)	Internet TCP/IP
Analyze the performance of remote LAN segments.	Internet Toolkit	Internet TCP/IP
Identify the Node names of TCP/IP stations so that the LANMeter instrument can use names instead of Hex addresses.	Segment Discovery	Internet TCP/IP
Verify network connectivity. Given an IP address, find out the MAC address.	ICMP Ping	Internet TCP/IP
Identify stations by IP address that are sending and receiving the most traffic.	Top IP (Top Senders and Top Receivers)	Internet TCP/IP
Identify misconfigured routers and hosts. Find congested routers and gateways. Locate routing loops.	ICMP Monitor	Internet TCP/IP
Find route to an IP host.	Trace Route	Internet TCP/IP
Analyze IP traffic flow for router load balancing.	IP Matrix	Internet TCP/IP

**Table 13. Banyan VINES Client/Server Connectivity**

To Do the Following Task	Use This Test	Under this Test Category
Identify available VINES devices that can provide a VINES client with a dynamic VIP address.	Address Servers	Banyan VINES
Discover available VINES servers, local or remote	Server Discovery	Banyan VINES
Identify stations (by VIP Address) sending and receiving the most traffic.	Top VINES (Top Senders and Top Receivers)	Banyan VINES

**Table 14. NetBIOS Configuration and Performance**

To Do the Following Task	Use This Test	Under this Test Category
Automatically have the LANMeter instrument assist in its own IP configuration for NetBIOS over TCP/IP environments.	IP Auto Config	NetBIOS
Discover the available NetBIOS domains and identify critical servers acting as Master Domain Controllers and Master Browsers.	NetBIOS Discovery	NetBIOS
Identify the node names of NetBIOS stations so that the LANMeter instrument can use names instead of Hex addresses.	NetBIOS Discovery	NetBIOS
Check the availability of a NetBIOS station for a variety of protocols.	NetBIOS Ping	NetBIOS
Identify NetBIOS stations that are sending and receiving the most traffic.	Top NetBIOS (Top Senders and Top Receivers)	NetBIOS

**Table 15. Utilities**

<b>To Do the Following Task</b>	<b>Use This Test</b>	<b>Under this Test Category</b>
Email, Print, Import, or Export files to or from LANMeter.	File Manager	Setup/Utils
Inspect or change the configuration of network devices using the LANMeter's serial connection.	Terminal Emulator	Setup/Utils
Remotely monitor the LANMeter instrument using a web browser.	Web Agent	Web Agent
Remotely control the LANMeter instrument using a web browser.	Web Agent (WebRemote Control)	Web Agent

# Index

- 100 MHz Cable Test Option, 2
- 100 MHz Remote, 2
  - Self Test, 34
- 100BASE-TX Cabling Systems
  - Selecting Connector Type, 37
- 100BASE-TX-to-AUI Adapter, 37
- 10BASE-T
  - Connection, 22
- 10BASE-T Cabling Systems
  - Selecting Connector Type, 37
- 10BASE-TX-to-AUI Adapter, 37
- 16 Mbps
  - LED Indicator, 22
- 3 ½-inch Utility Diskette, 4
- 4 Mbps
  - LED Indicator, 23
- AC Adapter, 4, 5, 24, 25
- Adapter
  - 100BASE-TX-to-AUI, 37
  - 10BASE-TX-to-AUI, 37
- Address Mode, 16
- Alphanumeric Keys, 18, 19
- Attaching Cables, 34
- AUI Connection
  - Selecting Connector Type, 37
- Auto Detect
  - Ethernet Speed, 29
- Auto Ring Speed, 29
- Auto Screen Backlight, 32
- Auto Test, 33, 42
- Backlight
  - Screen
    - ALPHA Key, 18
- Backlight, Auto, 32
- Battery
  - Charge Time, 25
  - Charger Status LED, 21, 24, 25
  - Charging State, 24
  - Fast Charging, 25
  - Low-Battery Indicator, 26
- Beacon Frame, 22, 29
- BNC
  - Connection, 36
  - Connector, 23
- Cable Identifier #0 Remote Adapter, 4
- Cables
  - Attaching, 34
- Caution
  - Fluke 686
    - and 683 Speed Configuration, 28
    - Selecting incorrect ring speed, 29
- Changing the Network Interface, 6
- Claim Token, 22
- Collision Frame
  - Late, 22
  - Local, 22
  - Remote, 22
- Configuration
  - Default Values, 26, 27
  - Fluke 686 and 683, 29
  - Menu, 27
  - Network Configuration, 28
  - Resetting Default Values, 27
  - Saving Changes, 27
  - Undoing Changes, 27
- Configuring
  - Instrument, 26
  - Tests, 9
- Connection
  - AC Adapter, 5

- BNC, 36
- Expert-T Autotest, 40
- NIC Autotest, 39
- TO HUB, 36
- TO MAU, 36
- TO NIC, 39
- Connector
  - AC Adapter, 5, 24
  - BNC, 23
  - Ethernet Types, 29
  - HUB/MAU, 23
  - Serial, 34
  - To NIC, 23
  - Token Ring Types, 29
- Connector Type
  - Selecting
    - 100BASE-TX Cabling Systems, 37
    - 10BASE-T Cabling Systems, 37
    - AUI Connection, 37
    - STP Cabling Systems, 38
    - ThinLAN Cabling Systems, 37
- Connectors
  - Fluke 680, 36
  - Fluke 682, 36
  - Fluke 683, 36
  - Fluke 685, 36
  - Fluke 686, 36
- Default Configuration Values, 26, 27
  - Resetting, 27
- Display
  - Changing Contrast, 8, 9, 17
  - Navigation, 17
  - Page Down, 17
  - Page Up, 17
  - Scrolling, 17
- Display Configuration, 32
- Enterprise LANMeter
  - Uses of, 3
- Equipment Supplied, 4
- Ethernet
  - Interface Icon, 4
  - Top-Level Softkeys, 41
- Ethernet Speed
  - Auto Detect, 100 Mbps, and 10 Mbps, 29
  - Configuring, 29
  - HUB LED Indicator, 23
  - MAU LED Indicator, 23
  - NIC LED Indicator, 23
- Expert-T Autotest
  - Connection, 40
- Expert-T Mode, 22
- File Manager
  - Introduction, 30
- Fluke 680
  - Labeling, 23
  - TO MAU Connectors, 36
- Fluke 682
  - Labeling, 23
  - TO HUB and BNC Connectors, 36
- Fluke 683
  - Fast Ethernet Capability, 2
  - Labeling, 23
  - TO HUB
    - and BNC Connectors, 36
- Fluke 685, 21
  - Labeling, 23
  - TO HUB/MAU and BNC Connectors, 36
- Fluke 686, 21
  - and 683, Configuration, 29
  - and 683, Speed Configuration Caution, 28
  - Fast Ethernet Capability, 2
  - Labeling, 23
  - TO HUB/MAU and BNC Connectors, 36
- Fluke 68x Series Instruments, 1
- Frame Check Sequence
  - Bad, 21
- Getting Started Manual, 4
- Hardware Revision
  - Of the LANMeter Instrument, 31
- Help Key, 18
- Hub, 22
- HUB/MAU Connector, 23
- Icon

- Ethernet Interface, 4
- Interface Mode, 4
- Token Ring Interface, 4
- Inserting Into the Ring, 22
- Instrument
  - Case, 4
  - LEDs, 34
  - Setting Up for Use
    - AC Adapter, 5
    - Attaching Cables, 34
    - Running a Test, 41
- Interface
  - Change, 6, 16
- Interface Mode Icons, 4
- Introduction, 1
- Key
  - ALPHA, 18, 19
  - Alphanumeric, 10, 19
  - Arrow, 16
  - Dedicated, 10, 15
  - ENTER/RUN, 15
  - EXIT/STOP, 16
  - Extended (Shift) Functions, 17
  - HELP, 18
  - MENU, 16
  - MORE, 15, 17
  - Print, 16
  - Red (Secondary) Key
    - Functions, 18
  - SHIFT, 17
  - SPACE, 19
  - TAB, 16
  - , 15
- Keyboard, 6, 10
- Keyboard Test, 33
- LANMeter Instrument
  - Default MAC Address, 31
  - Equipment Supplied, 4
  - MAC Address of the, 29
  - Uses of, 3
- LCD Display, 6, 8
  - Auto Backlight, 32
  - Display Configuration, 32
  - Parts of, 8
  - Screen Backlight
    - ALPHA Key, 18
- LED Indicators, 6, 21
  - 16 Mb/s, 22
  - 4 Mb/s, 23
  - Bargraph, 21
    - Network Utilization, 21
  - Battery Status, 21, 24, 25
  - Beacon, 22
  - BNC, 23
  - Collision, 22
  - For Fluke 685, 21
  - For Fluke 686, 21
  - Frame Error, 21
  - HUB, 23
    - Dual-Color, 23
    - Ethernet Speed, 23
  - Individual (status), 6, 21
  - Insert, 22
  - Instrument, 34
  - Link Active, 22
  - MAU, 23
    - Dual-Color, 23
    - Ethernet Speed, 23
  - Network Connector, 21
  - NIC, 23
    - Dual-Color, 23
    - Ethernet Speed, 23
  - Polarity, 22
  - Ring Error, 22
  - Transmit, 22
  - Using for Problem Isolation, 21
  - Wire Fault, 22
- Link Pulse, 22
- Lobe Test, 21
- Lobe Wiring Fault, 22
- Loopback Connector, 34
  - Making a, 34
- MAC Address
  - of the LANMeter Instrument, 29
- Manage Options, 30
- MAU, 22
- Neighbor Notification
  - Incomplete, 22
- Network Conditions
  - Shown on LEDs, 21

- Network Configuration, 28
  - Default Values, 28
- NIC Autotest, 22, 23
  - Connection, 39
- NIC Speed, 22, 23
- Options
  - Cable Remote, 2
  - Cable Test, 2
  - Manage, softkey, 30
  - SwitchWizard, 2
  - Terminal Emulator, 3, 31
  - WebRemote Control, 3
  - WideAreaWizard, 3
- Overview of Tests, 43
- Page Down, 17
- Page Up, 17
- Patch Cable
  - ScTP Cat 5, 34
- Polarity
  - Reversed, 22
- Pop-Up Menus, 9, 16
  - Accessing, 9
  - Closing, 15
  - Responding to Choices, 16
  - Using, 9
- Printing
  - ASCII Text, 16
  - To Serial Port, 16
  - To Virtual Disk, 16
- Remote
  - Self Test, 34
- Ring Error, 22
- Ring Purge, 22
- Ring Speed, 22, 23, 29
  - Auto, 29
- Running
  - a Test, 41
- Saving Configuration Changes, 27
- ScTP Cat 5 Patch Cable, 34
- Self Test, 33
  - 100 MHz Cable Remote, 34
  - Auto Test, 33
  - Keyboard Test, 33
  - Running, 33
  - Serial Test, 34
- Serial Connector, 34
- Serial Test, 34
- Setting Up Your Instrument, 4
- Setup/Utils, 26
- Softkey Labels, 8, 9
  - Highlighted, 14
  - Two Kinds, 14
- Softkey Tree, 11
- Softkeys, 7, 10, 11
  - Accessing Additional, 14, 15
  - Labels, 11
  - Second Level, 14
  - Top-Level, 9, 11, 14
    - Returning to, 16
  - Using, 11
- Software
  - Updating the LANMeter Instrument, 31
- Software Revision
  - Of the LANMeter Instrument, 31
- Speed Configuration
  - Fluke 686 and 683 Caution, 28
- Station Addresses, 16
  - Displaying Different Formats, 16
  - Dotted Decimal, 16
  - Hexadecimal (MAC), 16
  - Manufacturer Prefix, 16
  - Symbolic Name, 16, 30
- Station List
  - Usage and Description, 30
- Status Line, 8, 9
- STP Cabling Systems
  - Selecting Connector Type, 38
- Strings
  - Entering, 20
- SwitchWizard
  - Option, 2
- System Information, 31
- Terminal Emulator, 3, 31
- Test
  - Expert-T Autotest
    - Connection, 40
  - NIC Autotest

Connection, 39	Ethernet, 41
Overview of Tests, 43	Token Ring, 11, 41
Results, 16	Transmitting a Frame, 22
Running, 14, 41	Updating the LANMeter Instrument
Stopping, 16	Software, 31
ThinLAN Cabling Systems	User Interface
Selecting Connector Type, 37	Differences Between Ethernet and
Time and Date	Token Ring, 6
Setting, 31	Parts of, 6
TO HUB Connection, 36	Users Manual, 4
TO MAU Connection, 36	Warning
TO NIC Connection, 39	Do not connect, 34
Token Ring	WebRemote Control, 3
Interface Icon, 4	WideAreaWizard
Top-Level Softkeys, 41	Option, 3
Top-Level Menu, 8	Wire Map/Cable Identifier #0 Remote
Top-Level Softkeys	Adapter, 4
Ethernet, 11	Work Area, 8

**68x Series**  
*Getting Started*

---